

Project Name: _____ **Location:** _____

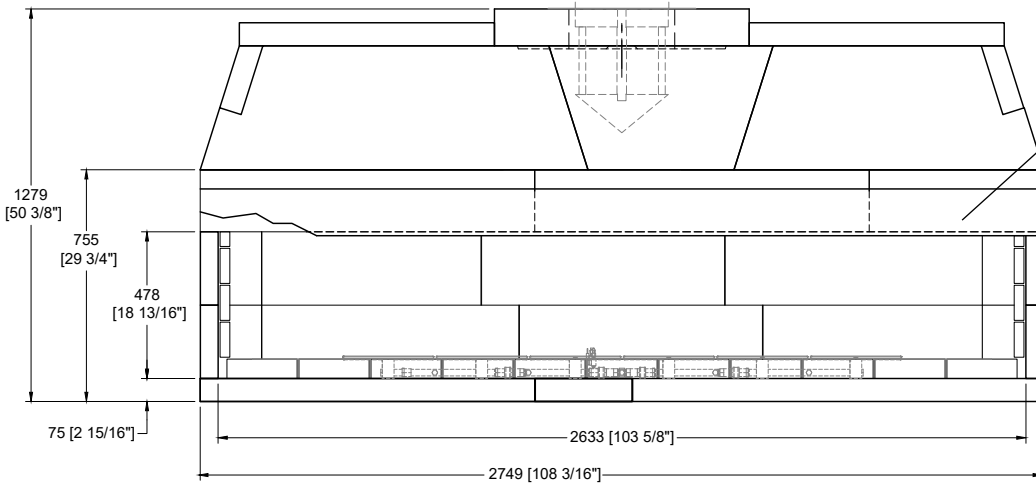

Front View

Steel angle:
6" x 6" x 1/2"
cut to span
firebox opening.
This item is not
included in the
components and
can be sourced
locally.

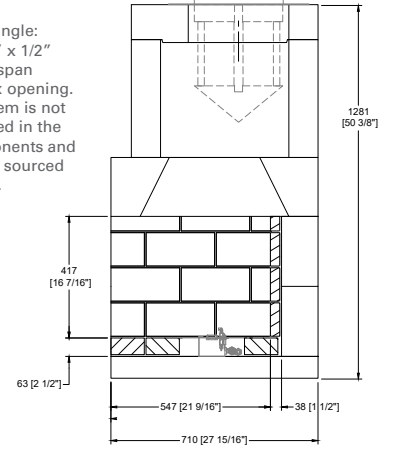

Side View

Uses one 12" B-Vent Chimney
with mechanical exhaust fan. Refer
to product manual for approved
Metal Chimney manufacturers.

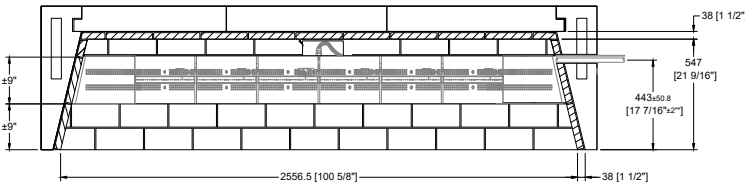

Plan View

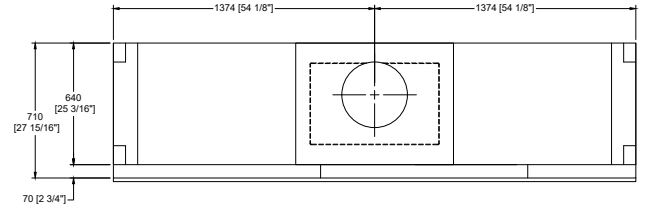

Top View

MINIMUM FRAMING DIMENSIONS

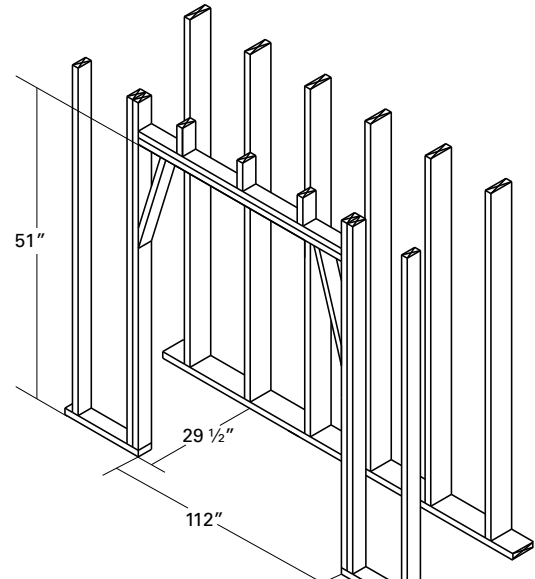

Framing dimensions
maintain 1 1/2"
clearance to
combustibles.
Refer to product
manual for further
installation
instructions.

FIREPLACE OPTIONS

- Hearth Height: _____
- Brick Type: _____
- Brick Color: _____
- Brick Pattern: _____
- Other Options: _____
- Gas Log Set: _____

Notes: _____

The total weight for the Maximus+ 96" linear fireplace is approximately 2,450 lbs. This dry weight includes fireplace pumice components only, additional weight from mortar, mechanical exhaust fan, glass media, firebrick and chimney not included.