

earthcore®

ECO-STEEL

Chimney Solutions



36" CHIMNEY SECTION



18" CHIMNEY SECTION



12" CHIMNEY SECTION

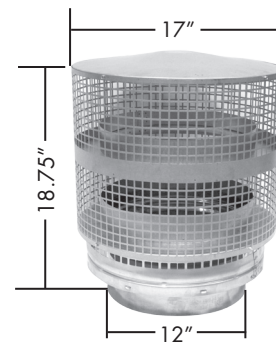

CTD ROUND TERMINATION

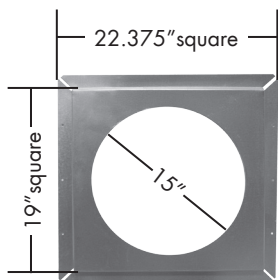

FIRESTOP

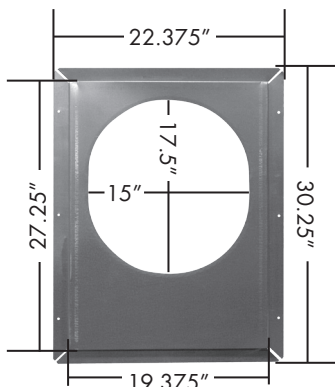

30 DEGREE FIRESTOP

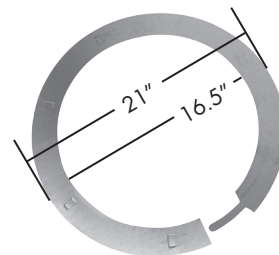

STORM COLLAR



30 DEGREE OFFSET



15 DEGREE OFFSET

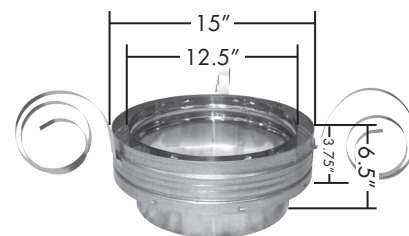

STABILIZER

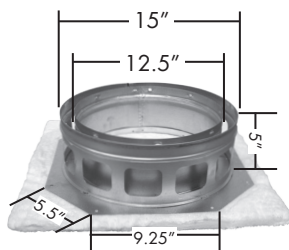

ANCHOR PLATE

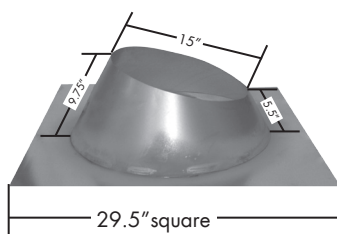

0 TO 6/12 FLASHING

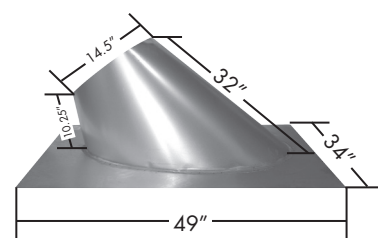

6/12 TO 12/12 FLASHING

*All measurements are rounded to nearest .25"