

# CHARRED HICKORY LOG PLACEMENT INSTRUCTIONS

## CAUTION.....WARNING.....IMPORTANT

USE ONLY ISOFLAMES/ISOKERN BURNERS AND VALVES WITH THIS ISOFLAMES/ISOKERN LOG SET.



ISF-CH-24 shown

# earthcore®

## LOG SET IMPORTANT INFORMATION

This instruction contains recommended log placement for these ISOFLAMES/ISOKERN logs which will promote good combustion and provide superior flame pattern and appearance. **Use these logs only with an ISOFLAMES/ISOKERN burner system.**

**Adequate ventilation is absolutely necessary!** Provided significant, noticeable sooting **does not** occur, some flexibility is possible in log placement to suit your individual preference (see Important below). If you experience a continued accumulation of black carbon (soot) on your logs it is an indication of incomplete combustion and you should move the effected log(s) so as to minimize the flame contact on the effected log(s). If significant sooting continues, stop using this gas log set.

Please read these instructions completely and carefully.

**Important:** Adequate ventilation is absolutely necessary. Adequate spacing between the logs is **NECESSARY** and **MUST** be maintained. Some carbon build up (sooting) may occur where flames strike the logs. If carbon build up (sooting) continues, rearrange top logs to allow more opening(s) for flame(s) before sooting becomes worse. **If any sooting occurs outside of the firebox (i.e. on the walls), turn off unit immediately and contact a qualified professional service technician.**

**WARNING:** Use **ONLY** ISOFLAMES/ISOKERN burners and valves with this ISOFLAMES/ISOKERN gas log set. **Failure to do so may result in property damage or personal injury, and will void listings, certifications, and invalidate claims made to Earthcore.** Contact your local ISOFLAMES/ISOKERN dealer if you need more information.

**This product is only warranted when used as part of an ISOFLAMES/ISOKERN vented burner system.**

**WARNING: This gas log set is for use with ISOLAMES/ISOKERN burners (and parts) ONLY.**

**CAUTION: Burn hazard! Logs will remain hot for some time after use.** If you need to reposition any log to maintain the proper layout, use heat resistant gloves or allow logs adequate time to cool before handling.

Failure to use ISOFLAMES/ISOKERN burners and valves may result in a **DANGEROUS** situation and in property damage, personal injury or even death; will void listings and certifications; and will void any insurance coverage by Earthcore or our insurers.

**BEGIN WITH THE GENERIC LOG AND EMBER STEPS BELOW, THEN LOCATE THE PAGE FOR YOUR SIZE CHOSEN TO COMPLETE PLACEMENT.**

**Generic Placement Steps**

**Important:** **DO NOT** place any embers on top of the flash tube to ensure proper operation. All models begin with the log and ember placement shown below. Continue with the appropriate section (on one of the following pages) specific to your log set.

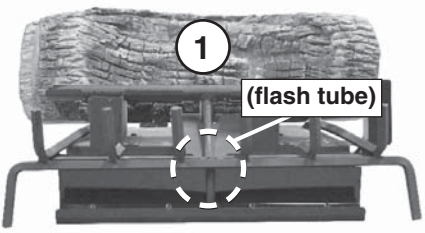
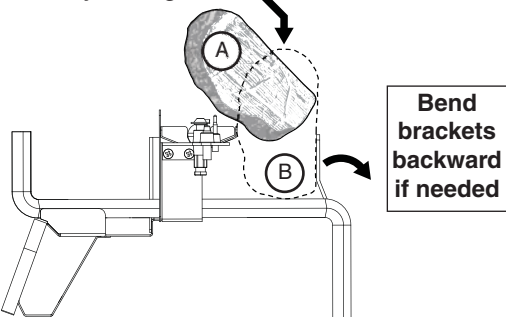

**Rear log placement detail:** First place the log, at an angle, against the rear burner brackets (see A). Then slide the log down into position – flat on the burner (see B).

Once placed, the rear log (log #1) should appear as shown. The log should rest flat between the rear brackets and top burner.

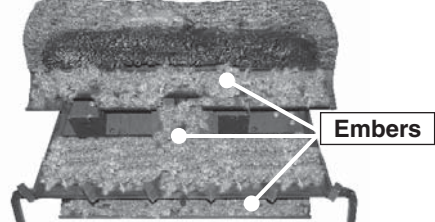
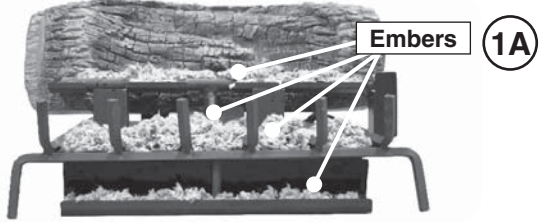

Place the supplied glowing embers evenly in the areas shown. **Break up any clumps that may have developed during shipment.** Store any excess embers if applicable.

Ember placement detail.

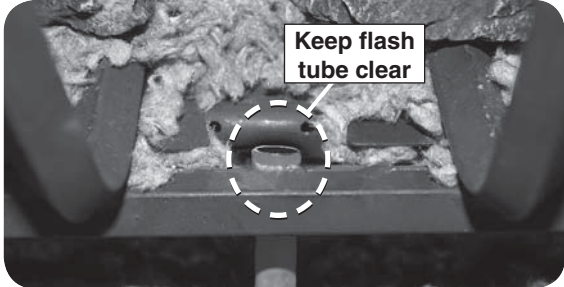

**DO NOT** place any embers on top of the flash tube to ensure proper operation. **Keep the area shown above clear at all times.**

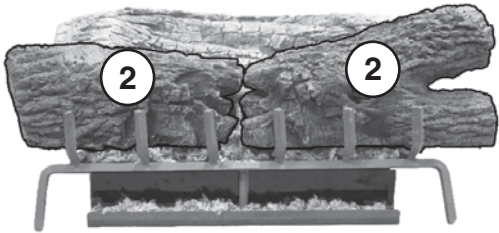

Place the left and right front log pieces (log #2) as shown. Rest the logs with their backs against the burner assembly behind them. **DO NOT** place the logs forward or on top of the grate fingers.

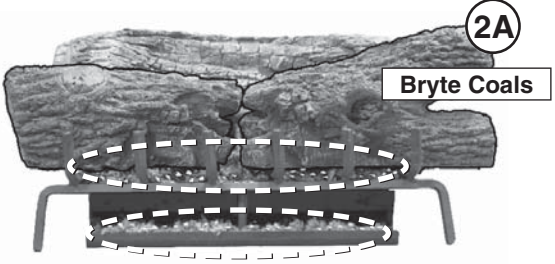

Separate half of the supplied bryte coals into small pieces, and evenly place them over the glowing embers in the middle ember bed as shown. Repeat this process for the remaining (second half) of bryte coals over the bottom ember bed.

# Charred Hickory Log Placement Instructions (24" model)

## ISF-CH-24 PARTS LIST

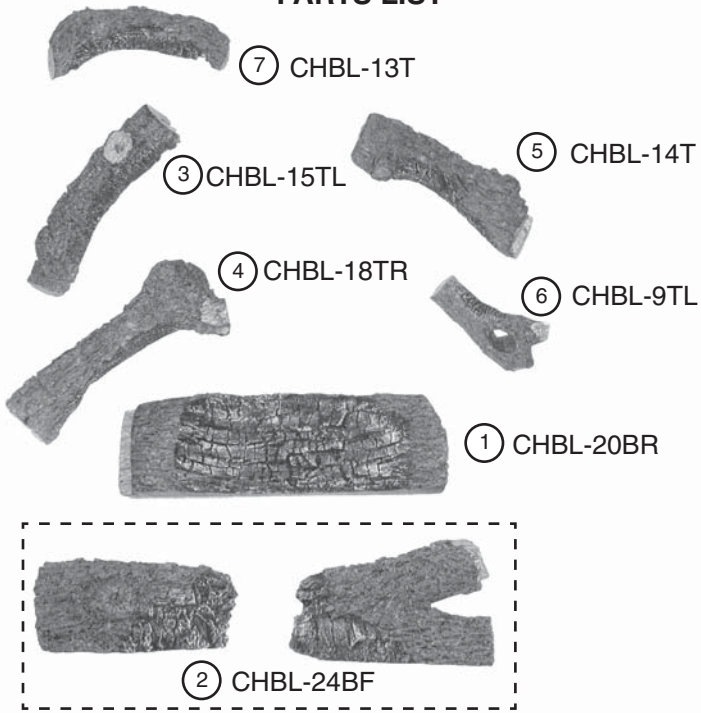

**CAUTION: Burn hazard! Logs will remain hot for some time after use.**

2 Boxes	Items
ISF-CH-24B (Bottom logs)	CHBL-24BF, CHBL-20BR
ISF-CH-24T (Top logs)	CHBL-13T, CHBL-14T, CHBL-15TL, CHBL-18TR, CHBL-9TL

**Refer to page 3 for details on proper bottom log and ember placement.**

**I**

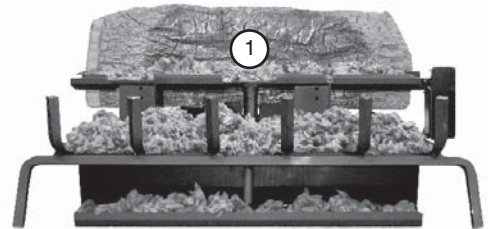

**II**

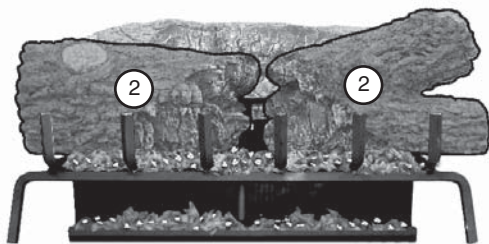

**III**

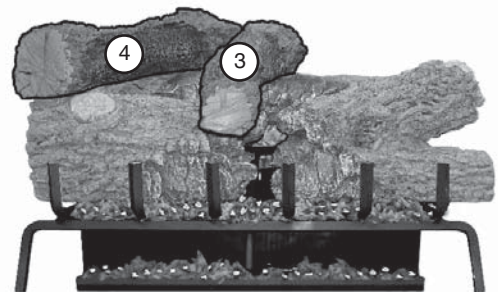

**IV**

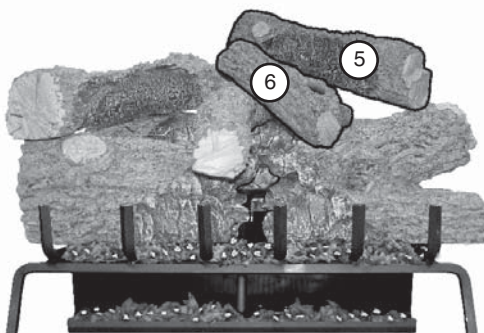

**V**

**Final Log Placement**

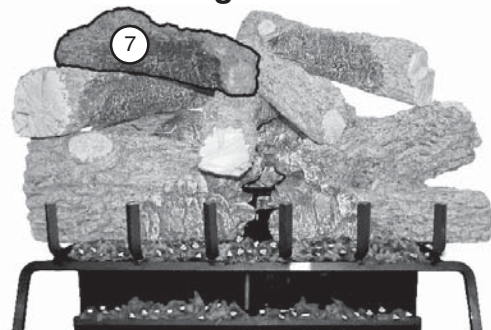



# Charred Hickory Log Placement Instructions (30" model)

## ISF-CH-30 PARTS LIST

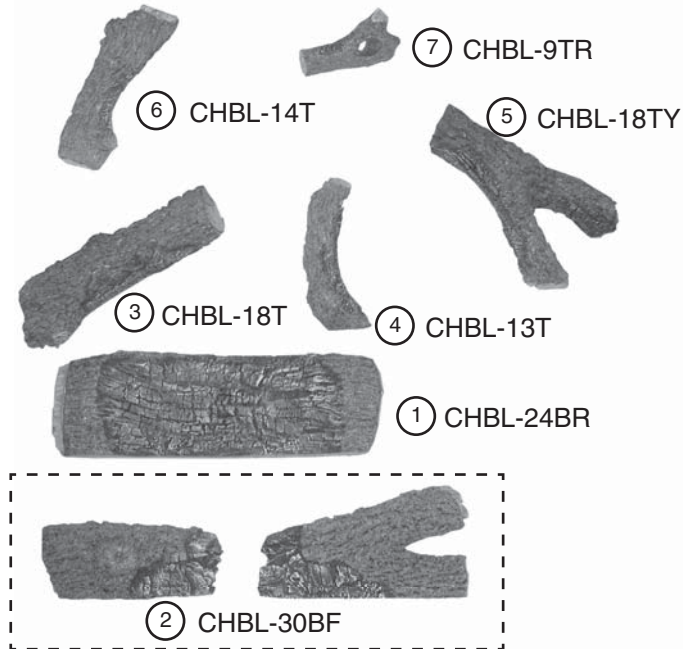

**CAUTION: Burn hazard! Logs will remain hot for some time after use.**

2 Boxes	Items
ISF-CH-30B (Bottom logs)	CHBL-30BF, CHML-24BR
ISF-CH-30T (Top logs)	CHBL-13T, CHBL-14T, CHBL-18T, CHBL-18TY, CHBL-9TR

**Refer to page 3 for details on proper bottom log and ember placement.**

**I**

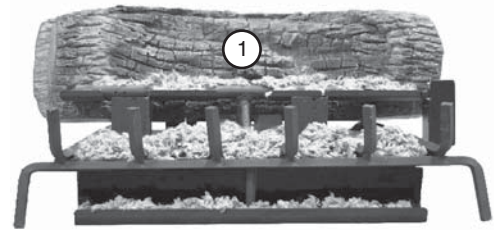

**II**

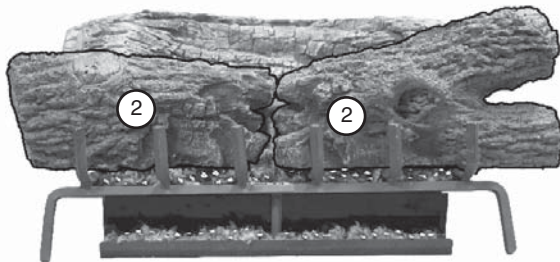

**III**

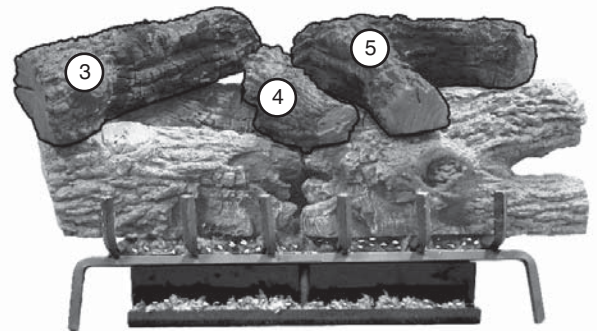

**Final Log Placement**

**IV**

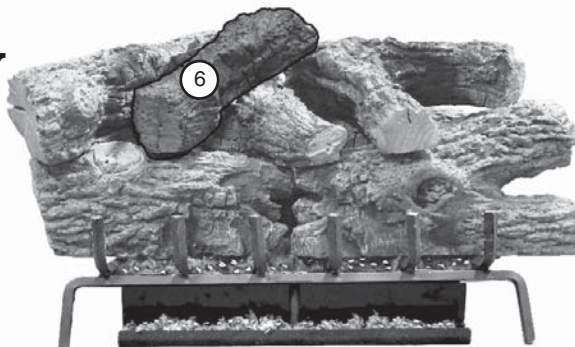

**V**

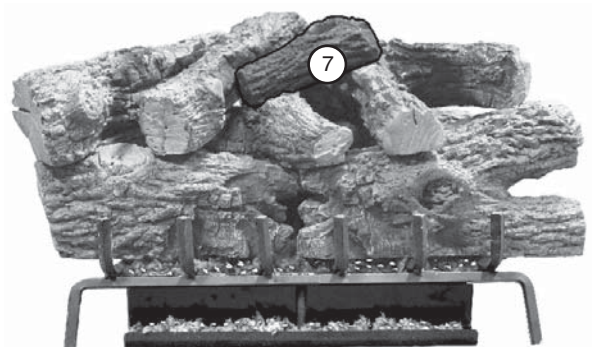

# Charred Hickory Log Placement Instructions (36" model)

## ISF-CH-36 PARTS LIST

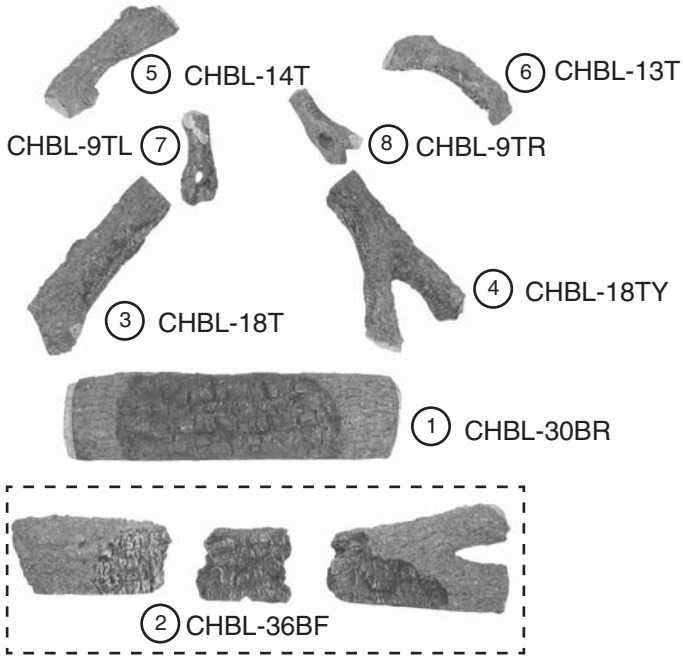

**CAUTION: Burn hazard! Logs will remain hot for some time after use.**

3 Boxes	Items
ISF-CH-30BR (Bottom rear log)	CHBL-30BR
ISF-CH-36BF (Bottom front logs)	CHBL-36BF
ISF-CH-36T (Top logs)	CHBL-13T, CHBL-14T, CHBL-18T, CHBL-18TY, CHBL-9TL, CHBL-9TR

**Refer to page 3 for details on proper bottom log and ember placement.**

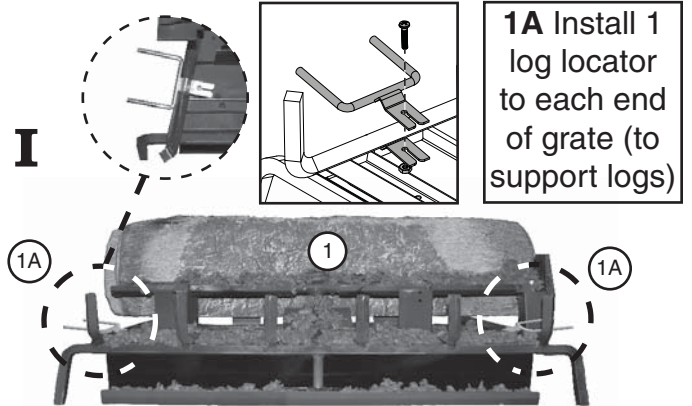

**II**

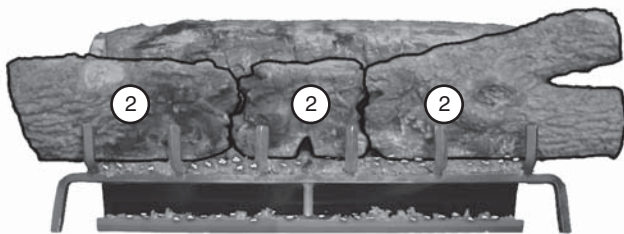

**III**

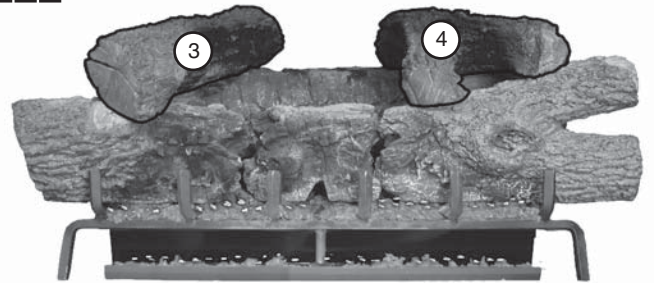

**IV**

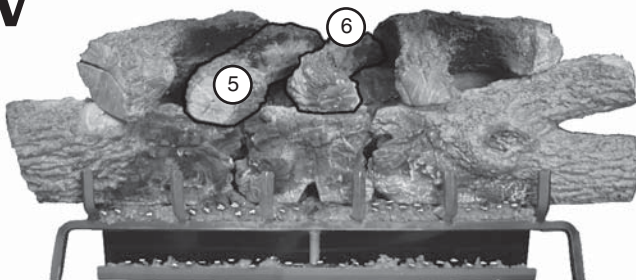

**V**

**Final Log Placement**

